

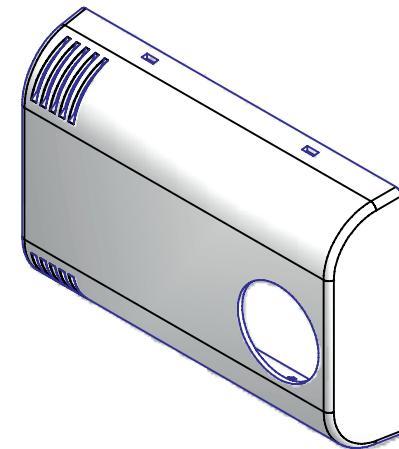

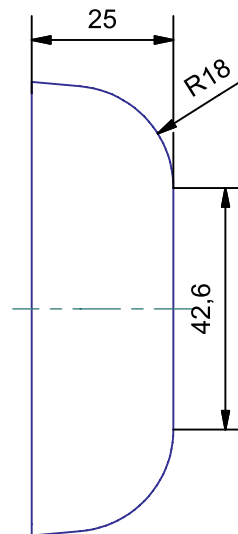

A-A

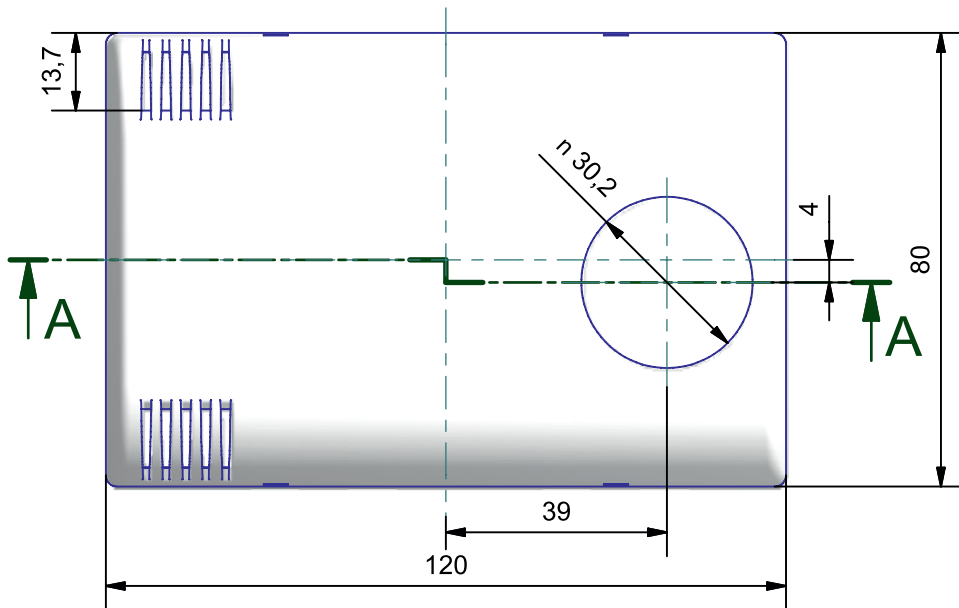

		Datum	Name		
	Bearb.	27.07.11	MB		
	Gepr.			Art.Nr.:	GH02KS030/050
	INDEX: 01			Beschr.:	Wandgehäuse mit Drehknopf

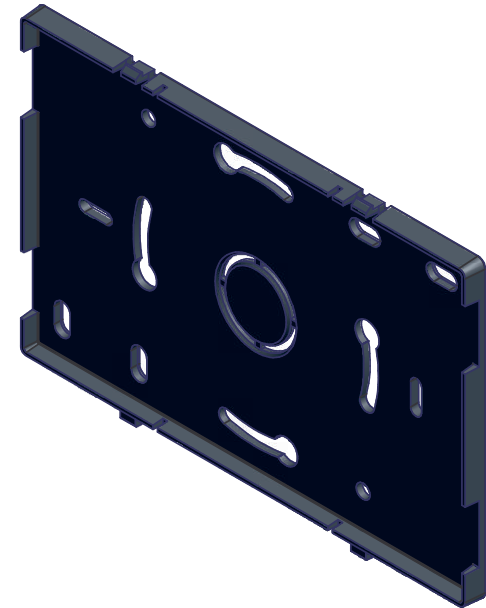
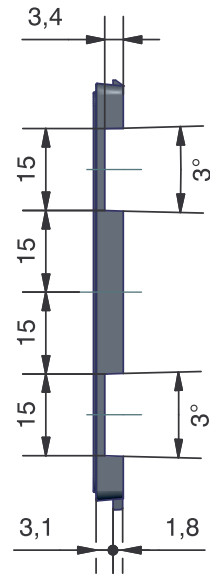
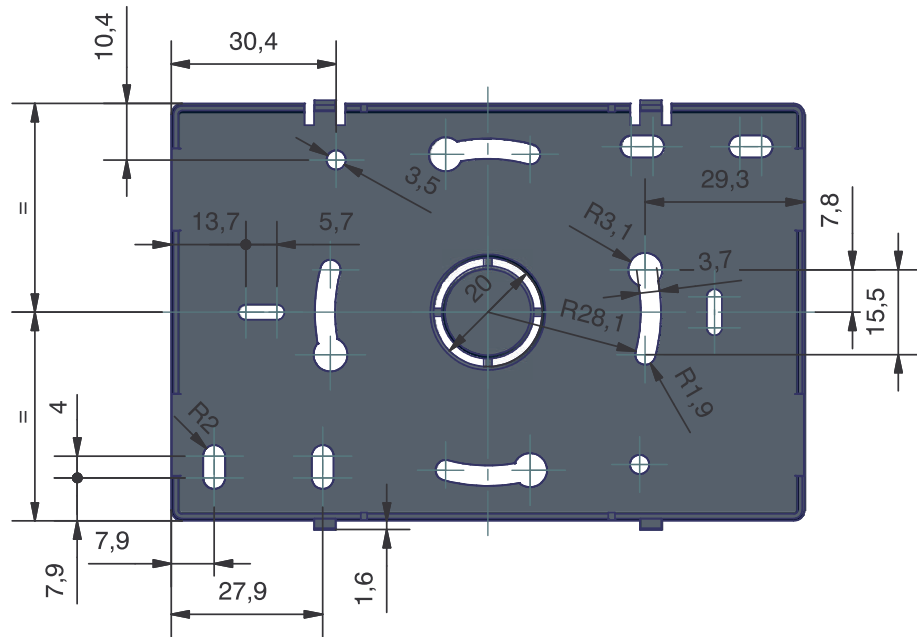
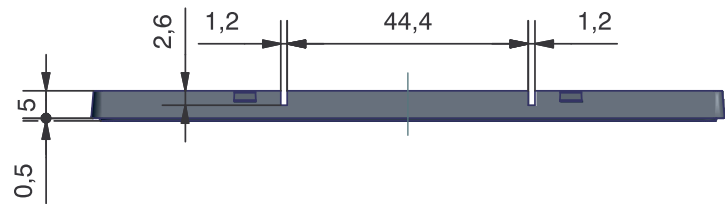

		Datum	Name		
	Bearb.	27.07.11	MB		
	Gepr.			Art.Nr.:	GH02KS030/050
	INDEX: 01			Beschr.:	Wandgehäuse mit Drehknopf